

Ultra High Brightness Hanging Double-Sided Installation Guide



Revision date: 02/08/2021

Instructions



Please read entire instruction sheet before you start.

Please be careful and use PPE equipment to avoid accidental damage or harm to the person. It is recommended to let someone who is experienced with electrical devices handle this. We are not responsible for any damage that is caused if the following instructions are not followed correctly.

Step 1

Please lay out all of the parts out of the box onto a carpet or protective foam to avoid damaging any of the parts. Please do not connect any of the cables to a powered on electrical device or outlet until the end of installation. Avoid pressure on the LCD panel as much as possible to avoid damage.

Step 2

Place the skeletal base bracket onto the floor and begin to feed the extension cables provided through the 2 holes on either side so that each of the cables come out of the base. Use the images below as references.



Feed the USB and HDMI cable into right side. You can also feed a LAN cable through if needed.



Feed the power cable and the second USB extension cable into the left side.



Step 3

Connect the cables fed through the bottom of the base to the base cover that has the switch attached to it. **When connecting the power cable, please make sure it looks exactly like below.**

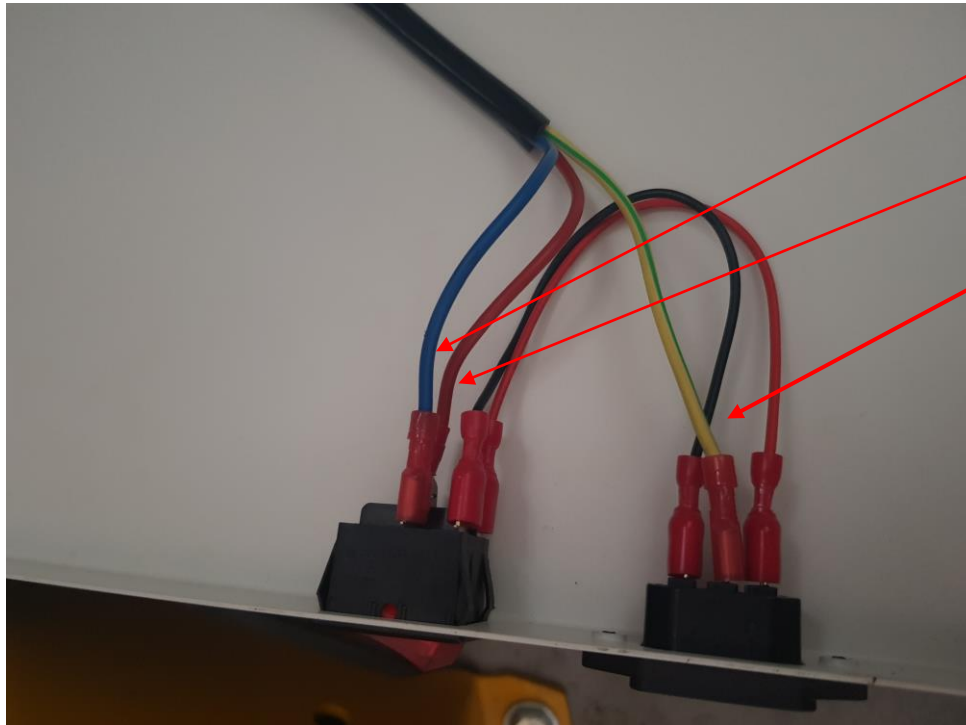

Neutral - Blue cable
Live - Red Cable
Ground - Yellow/Green cable

When looking at the connections head on:

Kettle Connector

Power Switch

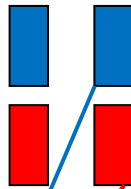
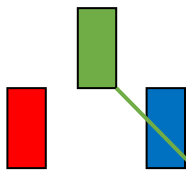

Key:
Red is Live.
Blue is Neutral.
Green is Ground



Power Cable

Make sure the connections match with each respective type. I.e. Live cables connect to Live connection points. Please do not remove the plastic covering on the end of the cables.

Step 4

Connect the HDMI and USB cables to the cover by removing the screws and re-attaching them at the other end.



Step 5

Disassemble the 2 arms that come with the screen and re-assemble these to the screen as shown in the diagram below.

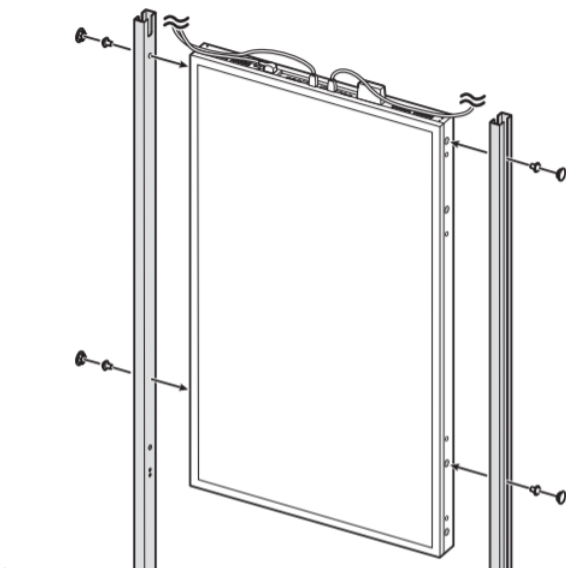

Step 6

Fix the arms on to both sides of the floor bracket using the large screws provided. Make sure that the side with the switch on is on the inward side of the screen.

Note: The outward facing side of the screen is the one that features the ambient light sensor.



Step 7

Place the covers on the base after attaching the screen and screw them together on both sides.





Step 8

Feed the extension cables through each side of the uncovered mounting arms all the way to the end. Whilst looking at the outward side of the screen - on the top right corner of the screen there will be a USB cable and mains power terminal block, these should be connected to the USB extension and power cables fed through the mounting arm. See diagram and images below for reference.

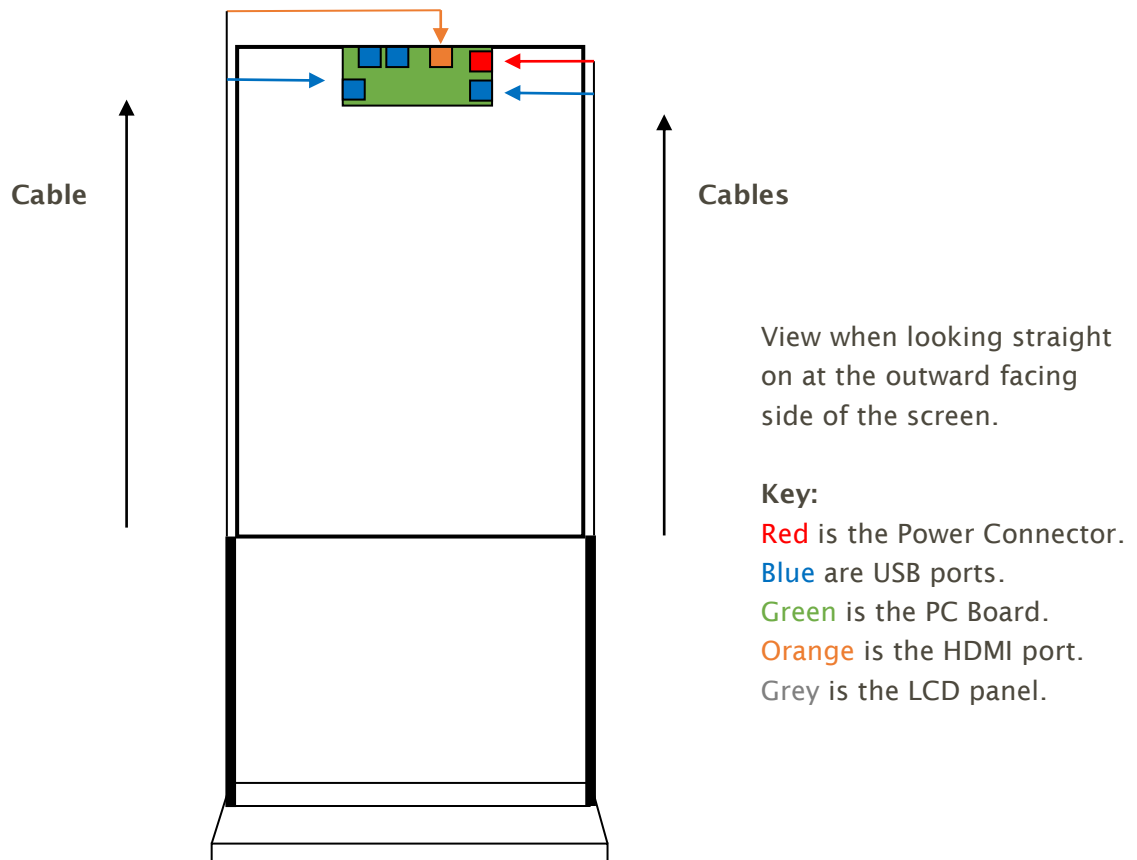

Power Cable Connection

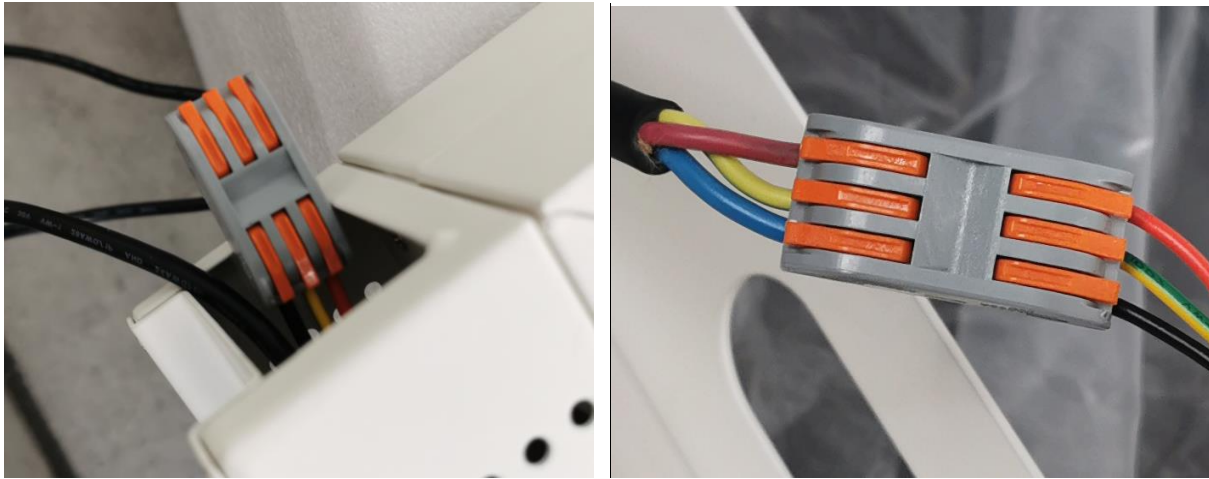

Red to Red (**Live**)

Green/Yellow to Green/Yellow (**Ground**)

Black to Blue (**Neutral**)

Connect the HDMI and USB extension cable on the other side following the diagram above. You will have to plug the HDMI cable and other optional cables into the port the top of the screen as shown below.

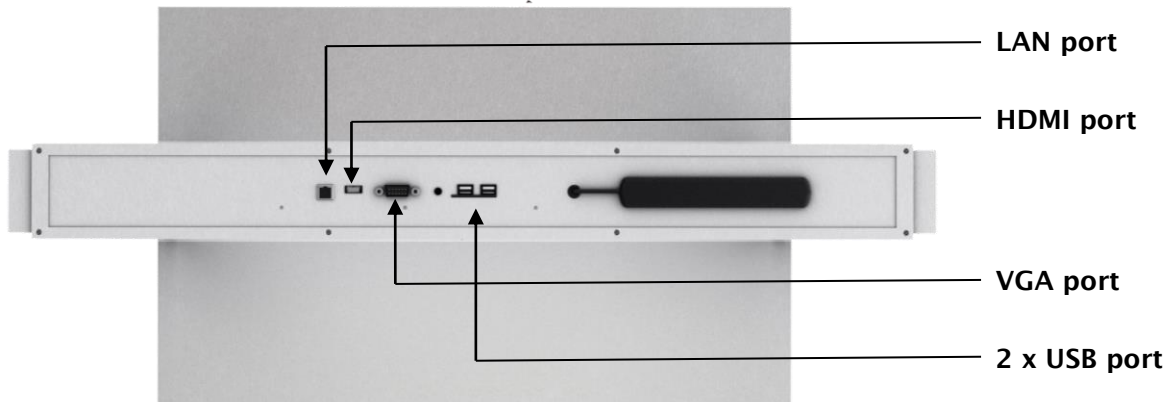

Step 9

Plug the provided kettle cable into the stand, switch the screen on using the switch and make sure all cables are working as intended. If everything is working correctly, please re-attach arm covers.

